

Duraform® ProX™ GF

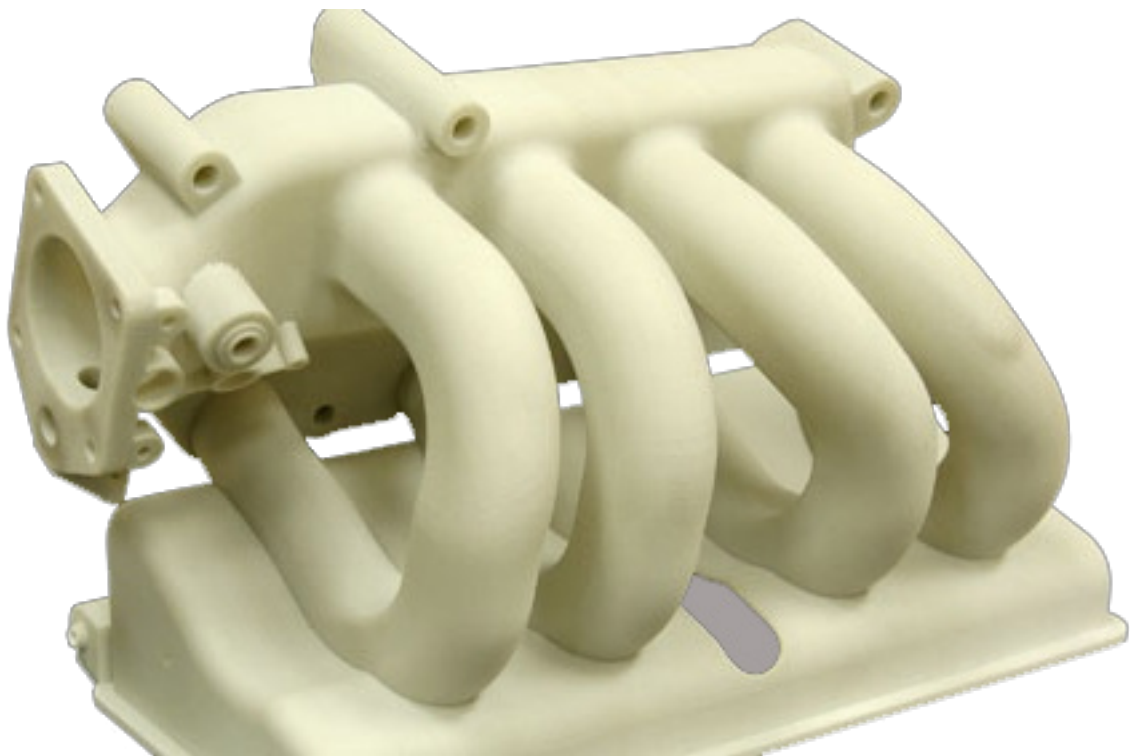

Material Guide

Original Instructions

CONTENTS

1	APPENDIX A – LEGAL NOTICES	1
	COPYRIGHT AND CORPORATE IDENTITY	1
	LIMITATIONS OF WARRANTY AND LIABILITY	1
	TRADEMARKS AND REGISTERED TRADEMARKS	1
2	PRINTING PARTS WITH DURAFORM® PROX GF MATERIAL	2
	SAFETY NOTICE: MATERIALS	2
	HOW THE DuraForm ProX GF PROCESS WORKS	2
	Warm-Up Stage	3
	Print Stage	3
	Potential Print Problems	4
	Interaction of Variables	4
	Cool-down Stage	4
	PRINT MODES FOR DURAFORM PROX GF	4
	PRELIMINARY PRINTS AND PART PRINTS	5
	Offline IR Calibration	5
	Scale and Offset Print	5
	Calculating Scale/Offset Values	5
	Build Setup Tips	5
	Orienting STL Files	5
	Fine Feature Definition	6
	PART PLACEMENT AND ORIENTATION GUIDELINES	7
	Cylinders	7
	Triangles	7
	Cross-sections	8
	Duplicating	8
	Features and Stair-stepping	8
	Closed Boxes, Cylinders, and Shapes	8
	Nesting	9
	Mating Surfaces	9
	BEFORE EVERY PRINT	9
	RESTARTING A TERMINATED PRINT	9
	SIFTING MATERIAL	9
	RECYCLING MATERIAL	10
	Blending Fresh and Used Material	10
3	POST PROCESSING	11
	TOOLS AND CLEANING MEDIA	11
	CLEANING PROCEDURES	11
	REPAIRING AND JOINING PARTS	11
	POWER SANDING	11
	WET SANDING PROCEDURE	11
	Tools and Equipment Required	12
	SEALING AND INFILTRATING PARTS	12
	SEALING WITH A WATER-BASED POLYURETHANE	12

Tools and Equipment Required	12
Procedure	12
SEALING WITH THERMAL-CURE SEALANTS	13
Tools and Equipment Required	13
Procedure	13

4 PROPERTIES AND HANDLING	14
SAFETY DATA SHEET	14
MATERIAL HANDLING	14
MATERIAL STORAGE AND DISPOSAL	14
General Storage Information	14
Storing DuraForm ProX GF	14
Material Disposal	14

5 SOLVING PROBLEMS	15
INTRODUCTION TO PROBLEM SOLVING	15
Problem Description Format	15
BONUS Z	16
CLUMPING	16
CRACKING OF PRINT BED	17
CRYSTALS AND CONDENSATION	17
CURLING, DURING PRINT	18
CURLING, POST-PRINT	18
Preventing Curl in Prints	19
GLAZING, DURING PRINT	20
GROWTH	20
MELTING, PRINT BED	21
MISSED SCAN	21
ORANGE PEEL	22
SHORT FEEDS	22
STRAY VECTORS	23
WASH OUT	23
WEAK PARTS/POROSITY	24

COPYRIGHT AND CORPORATE IDENTITY

COPYRIGHT

© 2016 by 3D Systems, Inc. All rights reserved. This document is subject to change without notice. The 3D Systems logo is a registered trademark of 3D Systems, Inc. This document is copyrighted and contains proprietary information that is the property of 3D Systems. The licensed user, in the name of whom this document is registered (the “Licensed User”) does not have the right to copy, reproduce, or translate this document in any way or to any media without the prior written consent of 3D Systems. No copies of the document may be sold or given to any person or other entity.

LIMITATIONS OF WARRANTY AND LIABILITY

This information is provided by 3D Systems for the convenience of its customers. It is believed to be reliable, but NO REPRESENTATIONS, GUARANTEES OR WARRANTIES OF ANY KIND ARE MADE AS TO ITS ACCURACY, FITNESS FOR A PARTICULAR USE OR THE RESULTS TO BE OBTAINED THEREFROM. The information is based in whole or in large part on laboratory work and does not necessarily indicate performance in all conditions. Notwithstanding any information provided by 3D Systems or its affiliates, the customer remains fully responsible for determining which federal, state or local laws or regulations, or industry practices are relevant to activities in which it engages, as well as assuring that those laws, regulations or standards are complied with under actual operating conditions, and 3D Systems undertakes no responsibility in these areas.

IN NO EVENT WILL 3D SYSTEMS BE RESPONSIBLE FOR DAMAGES OF ANY NATURE, INCLUDING SPECIAL OR CONSEQUENTIAL DAMAGES, RESULTING FROM THE USE OF OR RELIANCE UPON THIS INFORMATION. THE CUSTOMER ASSUMES ALL RISK RESULTING FROM THE USE OF THIS INFORMATION.

Customers use of the materials that follow is an acknowledgment of its agreement to the foregoing. Any customer not wishing to be bound should return this material to 3D Systems. Nothing contained herein is to be considered as permission, recommendation, nor as an inducement to practice any patented invention without permission of the patent owner.

TRADEMARKS AND REGISTERED TRADEMARKS

DuraForm is a registered trademark and ProX is a trademark of 3D Systems, Inc.

2 PRINTING PARTS WITH DURAFORM® PROX GF MATERIAL

DuraForm ProX GF is a glass-filled engineering plastic with good strength and stiffness, elevated temperature resistance and isotropic properties when used on the ProX 500 SLS systems. This guide describes how to use your ProX 500 SLS system to print parts using 3D Systems' proprietary DuraForm® ProX GF material. This chapter describes the printing process. It includes the following topics:

- Safety Notice: Materials
- How the DuraForm ProX GF Plastic Process Works
- Build Modes for DuraForm ProX GF
- Preliminary Prints and Part Prints
- Setting Up a Print
- Part Placement and Orientation Guidelines
- Before Every Print
- Restarting a Terminated Print
- Sifting Material
- Recycling Material
- Cleaning Up the SLS System

SAFETY NOTICE: MATERIALS

DuraForm ProX GF has been designed for and tested in 3D Systems' ProX SLS systems.



Caution: Using any material other than those certified by 3D Systems may cause health hazards and may limit the warranty of the SLS system.

HOW THE DURAFORM PROX GF PROCESS WORKS

The DuraForm ProX GF material process has the following characteristics:

- The material is heated to slightly below its melting point.



NOTE: The temperature set points may also vary slightly from machine to machine, due to differences in material conditions and sensors.

- The material is processed in an inert, nitrogen-rich atmosphere (5 .5% maximum oxygen).
- The material's melt transition allows it to be transformed from a solid to a low-viscosity liquid using a small amount of laser energy .
- Printing with the material consists of 3 stages:
 - Warm-Up Stage
 - Print Stage
 - Cool-down Stage



WARNING: THE OPERATOR MUST USE AN APPROVED VACUUM CLEANER TO CLEAN UP EXCESS MATERIAL. 3D SYSTEMS RECOMMENDS AN ESD OR EXPLOSION-PROOF MODEL. CONTACT 3D SYSTEMS CUSTOMER SERVICE FOR PURCHASING OPTIONS.

Warm-Up Stage

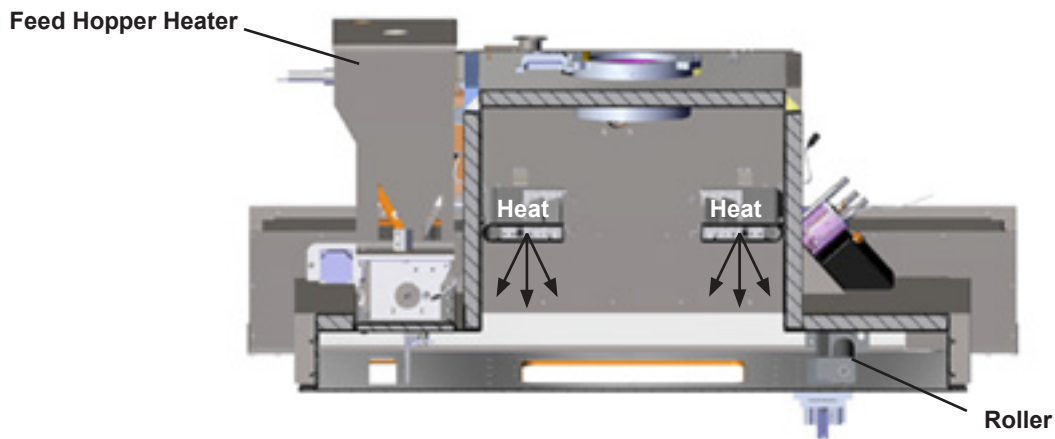

- The warm-up stage stabilizes the temperature in the print chamber, print bed, and feed hopper.
- This stage lasts approximately 60 minutes, during which the print bed piston indexes down in small increments (typically 0 .102 mm (0 .004 inches)) while the roller delivers material.
- During this stage, the system gradually increases the print bed temperature to the necessary point (below the material's melting point).
- In the feed hopper, the material is gradually increased to the highest possible temperature at which the material still flows freely. This limits the amount of thermal shock (cooling) caused by the feed material when it is first delivered to the print bed.

Superheat

The default print profile setting for the ProX 500 uses a technique called "Superheat." This technique enables the print to proceed more quickly and reduces potential problems such as curling.

Super-heating begins during the warm-up stage. The print bed reaches the superheat temperature that will be used during the build . This temperature will be maintained through the transition to the print stage (see below). Once in printing stage, the temperature will ramp down slightly and proceed with the rest of the print at that temperature.

Print Stage

- The print stage maintains the print bed and feed hopper temperatures.
- Laser energy is used to melt the material in each successive cross-section of the print.



NOTE: Laser power settings vary depending on the desired print output.

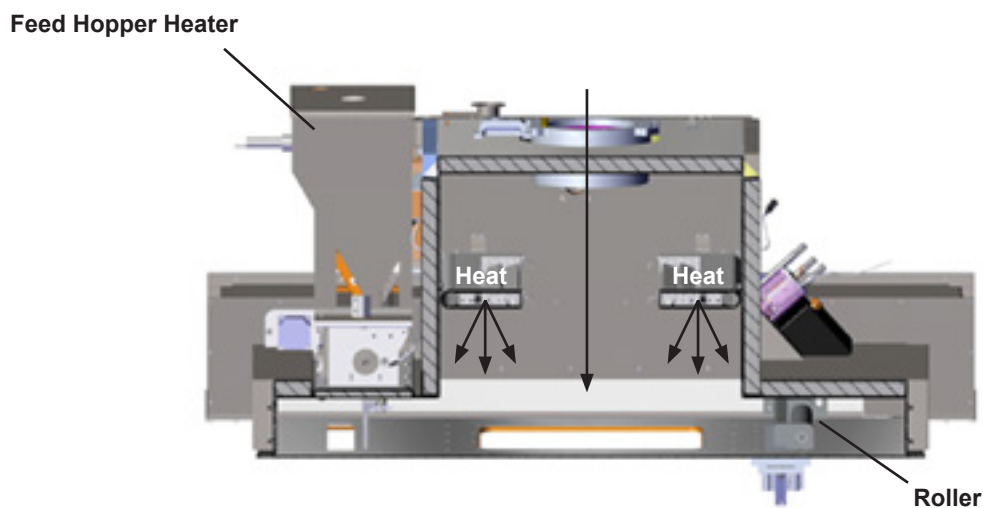

Potential Print Problems

- **Excessive laser energy** will affect material outside the cross-section of the part and cause growth.
- **Insufficient laser energy** does not fuse the part completely, which results in porous, weak parts.
- If the **print bed temperature is too low**, the parts will curl as the laser scans them.
- If the **print bed temperature is too high**, the parts will be difficult to remove from the surrounding material.
- If the **feed material temperature is too low**, the parts will be cooled too quickly when the material is rolled across the bed and the parts will curl.
- If the **feed material temperature is too high**, the material will not be released from the feed hopper and chute correctly, and the material will not roll correctly in front of the roller.

Interaction of Variables

Many of the problems just described involve variables that interact with each other. For example, excessive print bed heat or excessive laser power can cause growth. Refer to the sections titled “Growth” and “Weak Parts/Porosity.”

As the Print Continues

- The print bed piston indexes down, the parts are covered and begin to slowly cool.
- The mass and geometry of the parts influence the cooling rate. If the cooling rate is too high, the parts can develop post-print curl or warp . If the cooling rate is too low, growth can occur.
- The part’s position in the print also influences the cooling rate. The first parts printed have the highest cooling rate. First-order phase changes, such as solidification, occur isothermally; the top of these parts will not cool until the entire part has solidified. This slows the cooling rate of parts subsequently built.



NOTE: A piston heater heats the bottom of the print bed piston, which helps to slow the cooling rate. The part piston cylinder heater is used to slow the cooling rate and create a constant temperature across the print bed.

After the initial nitrogen purge, there is make-up nitrogen gas flowing at a constant rate through the print chamber during the print process. There is also nitrogen gas flowing across the laser window and the IR sensor head, and nitrogen gas is used to transport material from the Feed Overflow back to the Feed Hopper.

Cool-down Stage

- The cool-down stage allows the material, parts, and SLS system to cool sufficiently enough to safely remove the print cake from the print chamber.
- Nitrogen is required for this process and the inert level in the chamber needs to be maintained.
- The length of this stage depends on how large the print is. A larger print will take longer to cool down. The cool-down stage lasts approximately one-to-two hours.
- When this stage ends, the material and the SLS system are still hot.
- The print cake should be allowed to cool slowly to room temperature before removing the parts from the print cake. The core of the print cake should be no warmer than 50 °C.
- Removing the parts from the print cake too quickly could cause the parts to warp and/or discolor.
- Some part geometries are more susceptible to post-print warp than others.

Condensation in the Process

The DuraForm ProX GF Plastic contains a small amount of volatile material that vaporizes during processing. This material condenses on cool surfaces in the SLS system print chamber.

Refer to the section titled “Crystals and Condensation” for information on resolving problems with condensation.

- Heating the nitrogen gas flow across the laser window prevents the condensing material from depositing on the laser window.



NOTE: It is normal to see some slight condensation (or film) on the laser window after a print, but excessive condensation on the laser window can block laser power, causing weak or porous parts.

- Heating the IR sensor core and flowing nitrogen gas across the IR sensor head helps prevent condensation from forming on the IR sensor lenses. Excessive condensation on the lenses will cause inaccurate readings of temperatures, leading to hard or melted material in the print bed. The IR sensor should be inspected before each build and cleaned if necessary.

The laser window should be cleaned before each build . Refer to the section titled “Cleaning the Laser Window.”

PRINT MODES FOR DURAFORM PROX GF

DuraForm ProX GF is available in two print modes namely the Standard Production (SP) Mode and the High Production (HP) Mode.

The default mode or the recommended mode by 3D Systems is the SP Mode. HP Mode is available for customers who are interested in increasing their productivity. HP Mode results in about 30% lower total print time in comparison to the SP Mode. Conversely, HP Mode also results in about a 10% drop in mechanical properties. HP Mode uses different process settings than the SP Mode. Material configuration files for both the modes are offered by 3D Systems. The process settings in these configuration files have been optimized for each of these and provide a good starting point to operate while using one of these modes.

Please refer to the Customer Information Bulletin (Tips & Info) document for more detailed information about the SP and HP modes. The CIB also covers a list of key process parameters that are different between these modes. Expected mechanical properties and densities with each of these modes are also listed in the CIB.

PRELIMINARY PRINTS AND PART PRINTS

Before performing the first print, you must perform an offline IR calibration. Refer to your printer's User Guide for detailed instructions.

Offline IR Calibration

1. Put the system in Manual Operations mode, close and lock the print chamber doors.
2. Click the IR Calibration button.

Scale and Offset Print

When you print parts with DuraForm ProX GF Plastic, you will perform at least one preliminary print to fine-tune the default parameters you need to use when you print parts for use.

Either the field engineer or the operator will print a preliminary part to verify the appropriate scale and offset parameters. For details, see "Calculating Scale/Offset Values" on page 7.

Use parameters from the preliminary prints to print actual parts. During printing, continue to monitor the laser and heater setpoints by checking the quality of the parts and material during breakout.

Calculating Scale/Offset Values

Refer to the Build Setup Help in the Build Setup software.

Build Setup Tips

- The optimum print area for parts is a 341 x 290 mm (13 .5 x 11 .5 inches) rectangle.
- You may find it advantageous to organize the STL files into layers for the print job. Separate the layers of parts in Z by 1 .25 mm (0 .05 inches).
- Due to the high processing temperatures, parts placed at the bottom layer of the print may not cool evenly and may tend to curl during printing. See the sections "Curling, During Print" and "Curling, Post- Print."

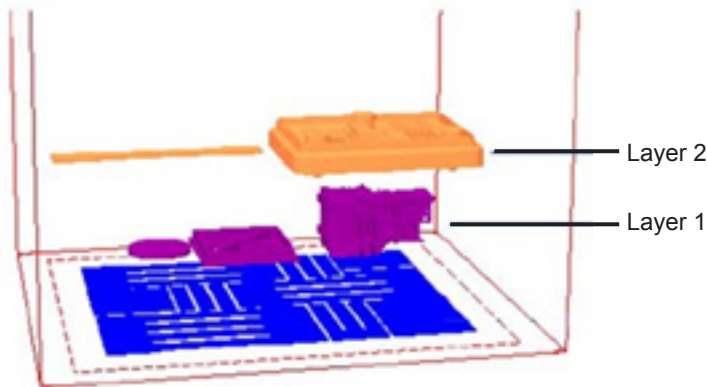

- If an STL file has a thick cross-section, you might want to place it higher in the print cylinder, such as Z = 127 mm (5 inches).
- Thick cross-sections that have features with X-Y slices or Z depth greater than 12 .7 mm (0 .5 inches) are more likely to experience post-print curl. Refer to the section titled "Curling, During Print."

Orienting STL Files

You can use the Build Setup application to orient an STL file to improve features such as thin walls, small pegs, text, small protrusions, or cuts.

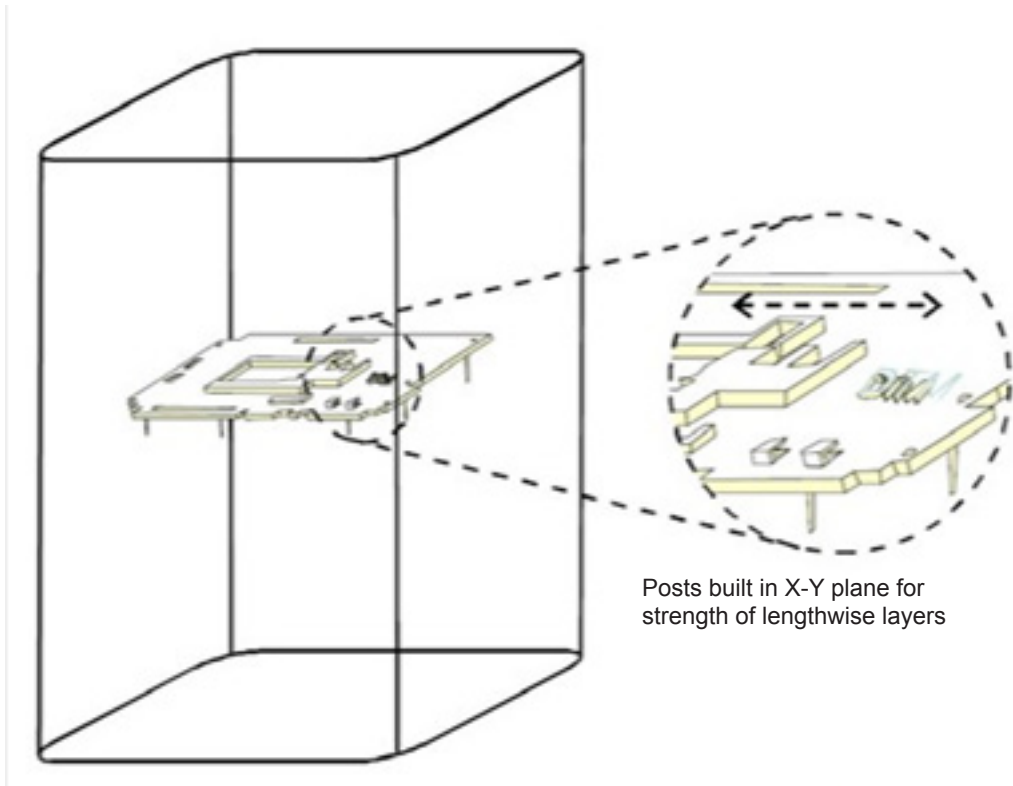

Posts built in X-Y plane for strength of lengthwise layers

Fine Feature Definition

While parts will have good detail on both upward- and downward-facing surfaces, generally the upward-facing surface will have the best definition.

Laser Beam Offsets

Outline/Fill Laser beam offsets adjust the outline of a part to compensate for the width of the laser beam. This does not compensate for regular shrinkage; rather, beam offset performs a topological offset, moving the skin of the part toward the inside. Features like posts become smaller and features like holes become larger. Beam offset is performed on each slice of the part as it is sliced.

The beam offset values are set using the following offset parameters: X Fill Offset, Y Fill Offset, X Outline Offset, and Y Outline Offset. These parameters are set using the Scale & Offset Editor in Print (Build) Setup.

If offset values are too large, very small features (less than 0.5mm) may not print. Build Setup allows the user to preview the print slices

Feature Strength

Orient features (such as snaps and pegs) that are subject to bending stress in the X-Y plane, so that layers run the length of the features.

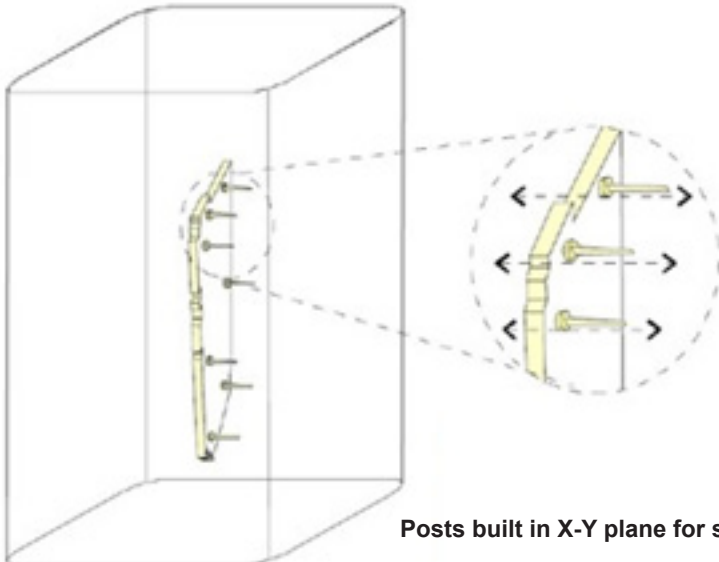

Posts built in X-Y plane for strength of lengthwise layers

Surface Finish

Curved surfaces built in the Z direction may display stepping because of the layered process.

PART PLACEMENT AND ORIENTATION GUIDELINES

There are several rules that need to be followed, whenever possible, to ensure that your parts print properly, and to get the most life out of your material.

CYLINDERS

Cylinders print better if placed vertically in the print area. This eliminates Z stepping on the sides of the cylinder. If the cylinder is very long, and of a small diameter, it can be placed on its side.

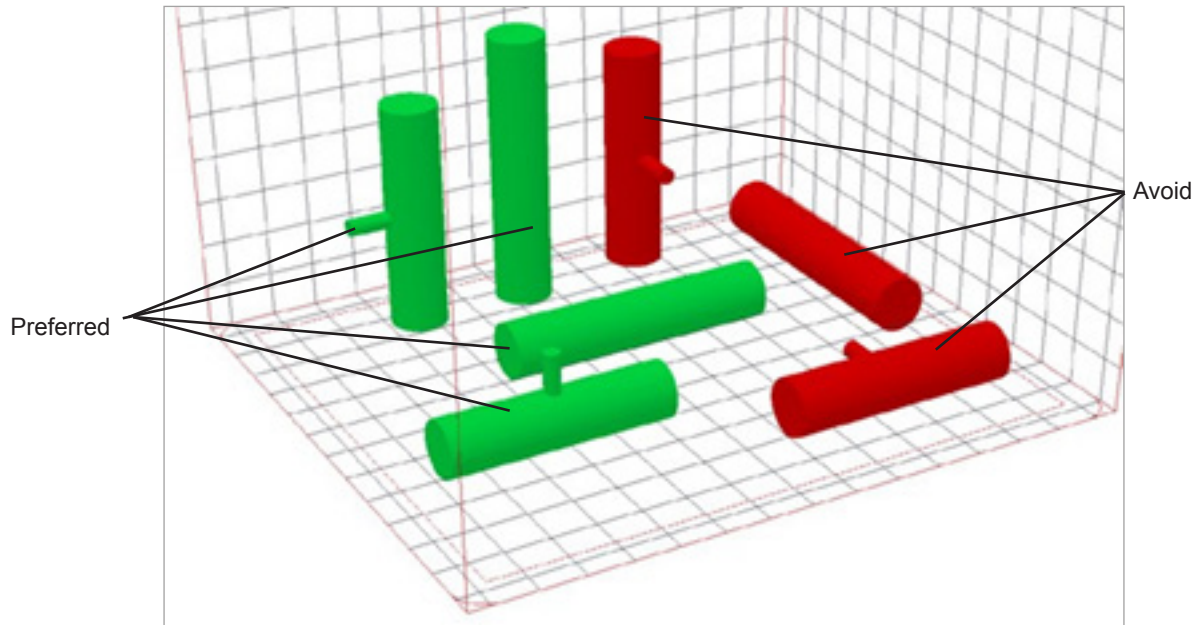

Building a cylinder horizontally is faster, but building it vertically produces a better surface finish. If the cylinder has another smaller cylinder attached to it, and is lying down, make sure that the smaller cylinder is facing in an upward orientation. If standing up, orient the smaller cylinder in the direction of the roller.

Triangles

Try to place the triangular shapes in the print so that none of the three sides are perpendicular to the direction of the roller motion, and the base is not at the top of the orientation. This offers less resistance to the material as it flows across the print bed, thus reducing the possibility of shifting, and will result in a flatter base.

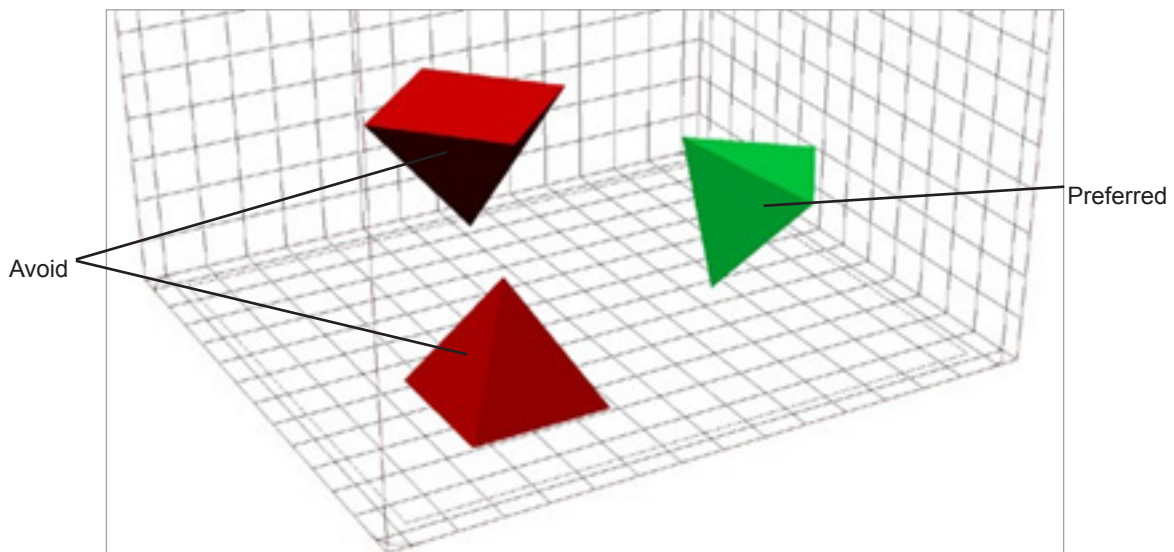

Cross-sections

Larger cross-sections should be placed in the upper part of the print to reduce the occurrence of post-print curl. If the cross-section covers more than half the print area, it should be rotated around the Y-axis enough so that the total area that is being scanned on any given slice is reduced. This will reduce the chance that you will short feed a large section. Rotating around the Y-axis will produce better strength than rotating around the X-axis, but may still cause a short feed if the section is too long in X.

Along with rotating around X and Y axes, rotating around the Z-axis also helps reduce distortion. Hence, for parts that are prone to distortion please also consider rotating around the Z-axis.

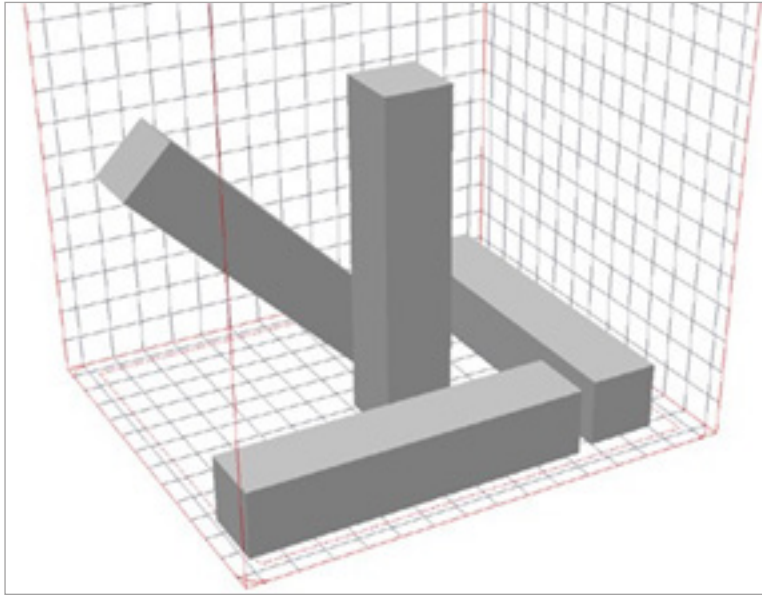

Duplicating

If you bring a part into the print, and then duplicate it to make several of the same part, pay attention to the cross-sections of the total parts. If there is an area of the part that contains a fairly heavy cross-section, make sure the parts are not aligned vertically, so that the large cross-sections happen on different layers. This will reduce the chance of short feeding the part bed. To improve print quality, it is recommended that you try to ensure that the time required for each layer is as consistent as possible. It is also possible to duplicate parameters. See the Build Setup help menu documentation for further details.

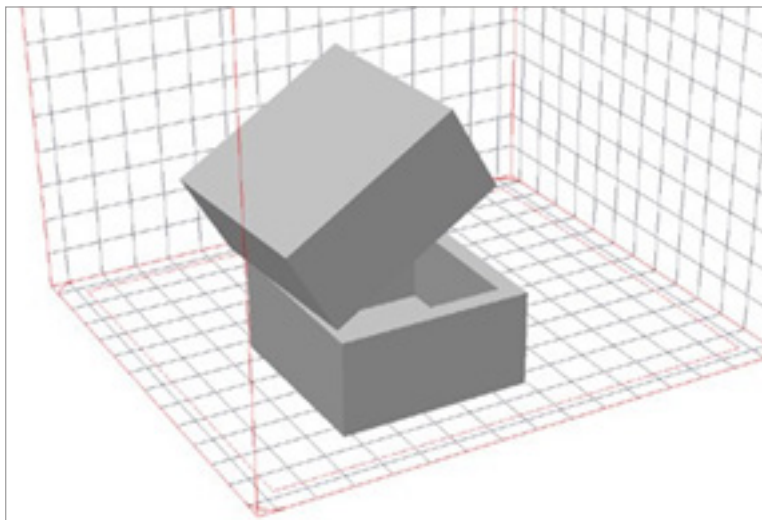

Features and Stair-stepping

Orient parts to achieve desired features. Detailed features and lettering print better on the upward-facing surfaces of a part. Downward-facing surfaces exhibit a reduced, or softened, stair-stepping effect.

Closed Boxes, Cylinders, and Shapes

Geometries that are closed on all sides but one should be placed in the print with the open side facing up. This reduces heat buildup in the print cake and the part, making breakout easier and extending material life.

Nesting

You can nest smaller parts within larger ones to utilize more of the print area, as long as the smaller parts can be removed after printing. If you nest parts, you should maintain a minimum of 0.250 inches (6.35mm) between the closest walls of each part to the others. The part containing the nested parts should always be facing with the open side up.

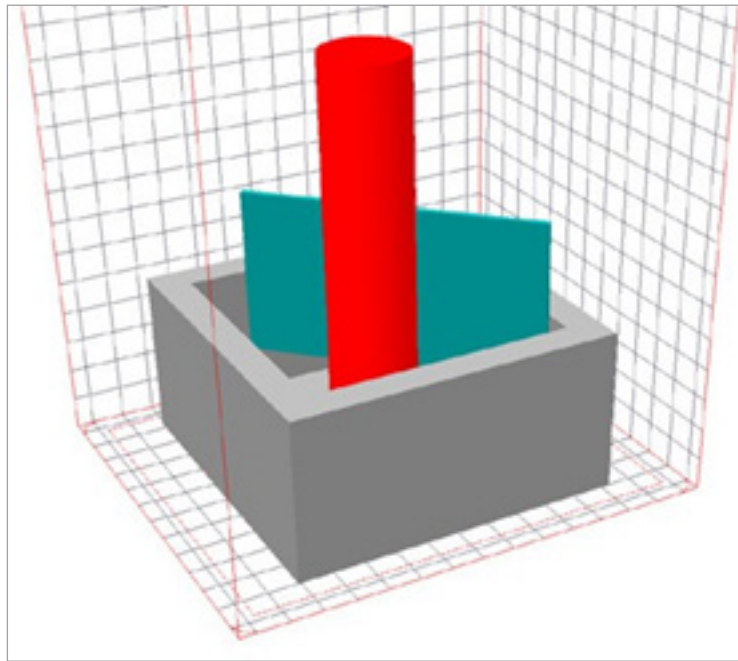

Mating Surfaces

Parts that are to be printed in more than one piece or parts that will have mating surfaces, should always be placed such that the mating surfaces are printed in the same orientation. It is preferable that the mating surfaces be printed facing upward for flatness. If this is not possible, print the mating surfaces in the Z-axis. The least desirable choice for orientation would be to print the parts with the mating surfaces facing down.

BEFORE EVERY PRINT

1. Verify that there is sufficient material in the MQC System.
2. Verify Laser Coolant Flow Setting. The flow setting is located on the coolant panel of the main system, behind the outer panel. The level should be greater than 6 liters/minute.
3. Verify that the IR sensor core temperature is 77 °C. The temperature is displayed in the Status Window. If the print chamber doors are open (or any interlocks are not made) the IR core heaters will not be on.
4. Verify that the laser window nitrogen flow setting is at 5 lpm.



NOTE: If you suspect a problem with your IR sensor core temperature control, contact 3D Systems Field Service.

5. Inspect the laser window and clean before each build, if necessary. Refer to the section titled “Cleaning Up the SLS System.”

RESTARTING A TERMINATED PRINT

If a print has been terminated, you will probably not be able to successfully restart it. The thermal conditions necessary for DuraForm ProX GF Plastic material generally does not allow for successful restarts of terminated prints.

SIFTING MATERIAL

To operate the Material Quality Control (MQC) System, refer to the ProX 500 User Guide . 3D Systems suggests the following sifting techniques for DuraForm ProX GF Plastic material:

- Do not remove the print cake from the print chamber until the print bed temperature is approximately 85 °C. Allow the print cake to continue cooling to 50° C before trying to break out parts.
- Remove loose material from the print cake with a brush. Sift the loose material into the used bin of the MQC System, but discard the hard and chunky material from the final breakout and part cleaning.
- Sift the loose material from the print cake between each print.



NOTE: When collecting material from the print cake, use only the soft powder from the outer edge . Powder that is hard and must be physically broken down should be discarded.

RECYCLING MATERIAL

To operate the Material Quality Control (MQC) System, refer to the ProX 500 User Guide.

After a print, loose material can be sifted and reused in another print. Consistent recycling procedures are important in order to maintain consistent material properties. If recycling procedures are not followed, problems such as variable shrinkages and surface imperfections like “orange peel” may appear.

The DuraForm ProX GF Plastic material is a very fine blend of small particles. As you run prints, the material is exposed to heat and energy, and the particles tend to stick together forming larger particles. You can combat this trend with sifting and blending. Sifting removes undesirable particles and blending adds new ones of proper size.

Blending Fresh and Used Material

The MQC System automatically initiates a blend cycle when it has enough material to blend a total of about 40 liters. For example, at a 50% fresh powder ratio, it requires about 20 liters in the fresh bin and about 20 liters in the used bin in order to initiate a new blend cycle. At any particular fresh powder ratio setting, the minimum volumes of fresh and used powder required to initiate a blend are displayed on the MQC home screen. The range for fresh powder ratio setting on the MQC System for DuraForm ProX GF material is from 50% to 100%. The default fresh powder ratio setting for DuraForm ProX GF material is 80%.

CLEANING UP THE SLS SYSTEM

Material may build up on the roller and in other areas in the print chamber, as well as on the MQC System. Refer to the procedures in the ProX 500 User Guide for the following cleaning information:

- Cleaning the SLS System Between Prints
- Cleaning the Laser Window
- Cleaning the Blackbody section
- Cleaning the Overflow Screen
- Cleaning the Sock Filter

3 POST PROCESSING

This chapter covers various techniques for improving part surface finish after breakout. This chapter is not meant to be a comprehensive discussion of post-processing techniques. Many companies develop their own techniques based on their unique needs. This chapter provides only basic information for finishing a part.

This chapter includes the following topics:

- Tools and Cleaning Media
- Cleaning Procedures
- Repairing and Joining Parts
- Power Sanding
- Wet Sanding Procedure
- Sealing and Infiltrating Parts
- Sealing with a Water-Based Polyurethane
- Sealing with Imprex Superseal

TOOLS AND CLEANING MEDIA

The following is a typical list of tools and cleaning materials that you can use for post-processing:

- Hand-held files
- Round sanding tools
- Flat sanding tools
- Sandpaper (approximately 150 grit)
- Glass media blaster with a recommended bead size of 70 to 140 μm .
- Cleaning cloth
- Pin vise with small drill bits
- Mini belt sander, with 120 grit sandpaper belts

CLEANING PROCEDURES

Before performing any other post-processing technique, thoroughly clean the parts. To clean a DuraForm ProX GF Plastic part, follow these instructions:

1. Remove the print cake from the print chamber.



Caution: 3D Systems recommends allowing the print cake to cool to room temperature before removing parts from it.

2. Brush away all loose material to expose the part.
3. Use appropriate hand tools to remove all remaining material in corners and holes. Use a drill bit to clear holes.
4. Using a glass bead media blaster at 4.8 bar (70 psi), hold the part approximately 127 mm (5 inches) from the nozzle and blast it.



NOTE: Holding the nozzle too close to the part can cause “burning” (surface discoloration and degradation).

For a better surface finish, continue with the “Wet Sanding Procedure.”

REPAIRING AND JOINING PARTS

3D Systems recommends cyanoacrylate (super) glues for repairing or joining parts made with DuraForm ProX GF Plastic materials. Use an accelerator with the cyanoacrylate. As an alternative, you can use a thin epoxy (such as a 5-minute epoxy).

POWER SANDING

You can use a mini-belt sander (with 5/16-inch belt, 120 grit, medium speed), if necessary, to remove layering on the side walls of parts printed with DuraForm ProX GF Plastic materials.

WET SANDING PROCEDURE

Tools and Equipment Required:

- Sand paper (220 to 1200 grit)
- Running water
- Cloth or paper towel for drying the part.

Complete the following steps to wet sand a part:

1. Dip the clean part in water.
2. Sand the surface until you achieve the desired finish. Start with 220 grit followed by 320 grit, 400 grit, 600 grit, and 1200 grit.



NOTE: After using 320 grit, be sure to change the water frequently.

SEALING AND INFILTRATING PARTS

Parts printed with DuraForm ProX GF Plastic materials can be sealed or infiltrated with a variety of products. These include primers, paints, polyurethanes, cyanoacrylates (“super glues”), and epoxies.

The parts tend to be dense, so low viscosity products, or products that can be thinned, are easier to use and can be important if your goal is to avoid changing the part’s dimensions.

For full infiltration, 3D Systems recommends that you use a vacuum chamber to infiltrate parts. If you only need a surface coat of sealant, then brushing or dipping is sufficient.



Caution: When working with infiltrants, use solvent-resistant gloves in a well-ventilated area.

Some suggested products:

- **Thermal-Cure Sealants: Godfrey & Wing Inc.**

220 Campus DriveAurora, OH 44202

Phone: +1 .330 .562 .1440

Toll free: +1 .800 .241 .2579

Fax: +1 .330 .562 .1510

<http://www.godfreywing.com/vacuum-impregnation/sealants/types-of-gw-sealants>

Part Number: 95-1000A + catalyst

- **UCAR Vehicle 443 Acrylic Emulsion:**

A Union Carbide product. Mix 72% emulsion with 28% water to create a 32% solid mixture. Dip the parts in this mixture for a surface coat. Use an industrial oven at 70° C to dry parts afterwards.

- **Cyanoacrylates:**

3D Systems recommends Loctite 408. For cyanoacrylates, use of an industrial oven or vacuum chamber is not recommended.

- Refer to the section titled “Repairing and Joining Parts.”

SEALING WITH A WATER-BASED POLYURETHANE

You can use any water-based polyurethane sealant to infiltrate and seal parts printed with DuraForm ProX GF Plastic materials.

Tools and Equipment Required

- Metal pans deep enough to submerge parts
- Foam brush or applicator (optional)
- Industrial oven (optional)
- Vacuum Chamber (optional)

Procedure

1. Sand the part before sealing, if desired. Refer to the section titled “Wet Sanding Procedure.”
2. Coat and infiltrate the part with sealant using one of the following methods:
 - Paint the sealant on with a foam brush.
 - Immerse the parts in a container of sealant for five minutes. If parts float, weigh them down or hold them down.
 - To fully infiltrate thick-walled parts (with walls more than about 7.5 mm (0.3 inches) thick), place them in a container of sealant

in a vacuum chamber until air stops bubbling out of the sealant.

3. Remove the part from the sealant and shake off the excess.
4. Use compressed air to blow excess sealant off of inside features and out of cavities.
5. Air dry the part for 4 to 24 hours, depending on part density and size. You can speed drying by using an oven at low heat (50 °C).

SEALING WITH THERMAL-CURE SEALANTS

Tools and Equipment Required

- Foam brush or applicator
- Thermal Cure sealant
- Convection Oven capable of at least 100 °C
- Vacuum Chamber (optional)

Procedure

1. Place the clean part on a tray to catch excess sealant.
2. Apply the sealant to one side of the part using the foam brush . Be sure the entire side is coated.
3. After the part face is coated, let the sealant sit on the part for 5 to 10 minutes to saturate the part surface.
4. Turn the part over and apply sealant to the back side of the part.
5. Set the oven to 100 °C. Remove any excess sealant and place the part in the oven for 1 to 1.5 hours or longer for parts with thick cross-sections.
6. Remove the part and apply a second coat of sealant, repeating steps 2 through 5.

4 PROPERTIES AND HANDLING

This chapter contains general information about DuraForm ProX GF Plastic, its properties and how it should be handled. It includes the following topics:

- Safety Data Sheets
- Material Handling
- Material Storage and Disposal

SAFETY DATA SHEET

3D Systems provides safety data sheets (SDSs) with safety and handling information for the DuraForm ProX GF Plastic material. The document control number (DCN) for DuraForm ProX GF Plastic SDS is:

- DuraForm ProX GF Plastic: **DCN 24169-S12-00-A**

MATERIAL HANDLING

For complete information, refer to the Safety Data Sheet (SDS) for DuraForm ProX GF Plastic.

Observe the following:

- Avoid spilling material on the floor, and clean it up promptly if you do. Spilled material can cause floors to be very slippery.



NOTE: The operator must use an approved vacuum cleaner to clean up excess material. 3D Systems recommends an ESD or explosion-proof model. Contact 3D Systems Customer Service for purchasing options.

- After vacuuming spilled material, use a wet mop to clean the floor.
- Due to the small particle size of DuraForm ProX GF Plastic material, it is likely to become airborne during handling.

For conditions where exposure to dust is likely, 3D Systems recommends a NIOSH-approved dust respirator for dust appropriate to the airborne concentration. Such conditions might include handling of material at the SLS system or the Material Quality Control (MQC) System.

MATERIAL STORAGE AND DISPOSAL

This section contains storage information for DuraForm ProX GF Plastic, as well as disposal instructions.

General Storage Information

For information regarding the MQC System, refer to the ProX 500 User Guide.

To avoid contamination, spilling, dust clouds, or mixing different types of materials, follow these guidelines:

- Store used material in properly labeled bottles. Be aware that they are subject to contamination, unless you seal them in some manner.
- Do not mix one type of material with another.
- Thoroughly clean the MQC System when changing materials.
- Thoroughly clean the SLS system machine when changing materials.

Storing DuraForm ProX GF

If the material becomes contaminated, its processing characteristics may change. This can produce undesirable results in part quality. The following storage guidelines suggest ways to minimize contamination and keep powder under optimum conditions:

- Store at a temperature of 40° C or less.
- Seal the container.

Material Disposal

When disposing of DuraForm ProX GF, follow any local ordinances and the guidelines in the Safety Data Sheet (SDS).

This chapter is organized alphabetically by problem name. It contains the following topics:

- Introduction to Problem Solving
- Bonus Z
- Clumping
- Cracking of Print Bed
- Crystals and Condensation
- Curling, During Print
- Curling, Post-Print
- Glazing, During Print
- Growth
- Melting, Print Bed
- Missed Scan
- Orange Peel
- Short Feeds
- Stray Vectors
- Wash Out
- Weak Parts/Porosity

INTRODUCTION TO PROBLEM SOLVING

While optimizing profile parameters can eliminate many problems, it is often useful to monitor a print so you can establish the process parameters.

There are two reasons to observe a print:

- Some parts may require attention and adjustment during the print.
- Your profiling will become more accurate through observation. As your profiling becomes more accurate, the need for future observation will become less frequent.

Problem Description Format

You will find the following information about each problem:

- **Description:** explains the problem and provides a visual representation of it. The description includes such things as “where” and “when” the problem might occur.
- **Theory of Cause:** contains a brief explanation of what might have caused the problem.
- **Visual Signs:** describes any observable information that may not be covered in the Description section.
- **Consequences:** details what can happen to print quality if you do not correct the problem.
- **Corrective Action:** describes what you can do to avoid or recover from any given problem.
- **Related Problems:** indicates whether this problem might interact with or be related to another problem.

BONUS Z

Description: “Bonus Z” occurs when the laser melts a part beyond the specified depth—usually 0.1 mm (0.004 inches)—on the first few scans. This causes vertical growth in the Z axis. The difference between growth and bonus Z is that growth may occur on any part edge, while bonus Z occurs only on downward facing surfaces.

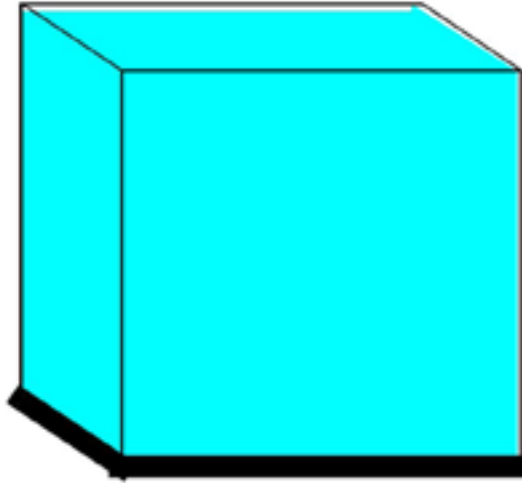

Theory of Cause: When the first layer is scanned, the laser penetrates to the unmelted material below the print boundary. In extreme cases, bonus Z will occur with wash out.

Visual Signs: You cannot observe this during printing.

Consequences: The part is out of tolerance in the Z axis .

Corrective Action: While printing, there are no corrective actions you can take .

Prior to beginning the print job, you can:

- minimize the possibility of bonus Z by reducing the **Fill Laser Power** parameter in the Print Profile for the first few layers (between the first and fourth layers).
- use the Z-growth compensation features of Build Setup; see your Build Setup help.

If bonus Z occurs, you can clean the part during post-processing by sanding or machining off the appropriate amount.

Related Problems: Refer to the section titled “Wash Out.”

CLUMPING

Description: agglomerated material on the material bed surface accumulates in front of the roller as it moves across the print bed, and streaks appear behind the roller.

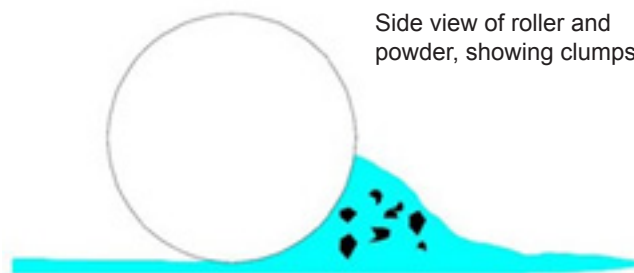

Theory of Cause: This is usually the result of one of the following:

- Improperly sifted, recycled material.
- Overheating the material in the feed hopper.
- Contaminants in compressed air or air line.

Visual Signs: The roller pushes clumps across the print bed, which may cause streaks to appear after the roller passes.

Consequences: Material does not feed properly, causing poor quality parts. Improper material feeding causes uneven material thickness, which may cause growth or inadequate melting. Streaks may be apparent on upward and downward facing surfaces of parts.

Corrective Action: Reduce the temperature set points for the feed hopper.

Thoroughly sift recycled material before using it. Refer to the sections titled “Recycling Material” and “Sifting Material.”

Make sure your material storage methods do not allow contaminants into the material. The section titled “Material Storage and

Disposal” describes appropriate material storage.

Make sure the supply for clean dry air meets the specifications given in your printer’s Facility Guide.

If clumping occurs in an area of the print bed that does not contain the part(s), you probably can continue the print job. If clumping occurs in the area of the print bed containing the part(s), you may not be able to complete the print job successfully.

If you terminate the print, do the following:

1. Discard any lumps of material.
2. Clean the print chamber.
3. Clean the roller.

Related Problems: Refer to the section titled “Cracking of Print Bed.”

CRACKING OF PRINT BED

Description: The surface of the print bed cracks open as the roller moves across it.

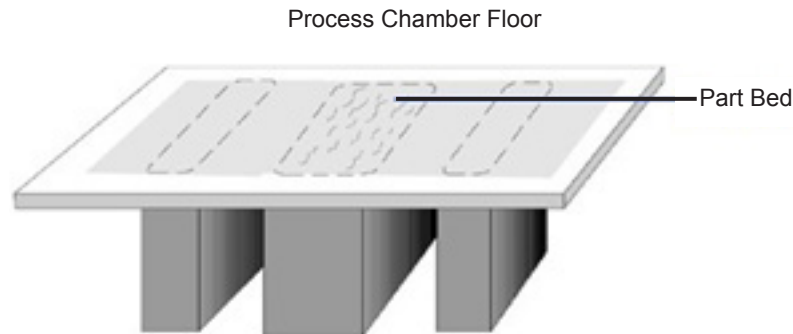

Theory of Cause: Excessive heating rate or temperature from the heaters causes partial melting of material on the print bed surface(s). Mechanical problems with the roller can also cause cracking of the print bed. If you suspect mechanical problems, contact 3D Systems.

Visual Signs: Cracks appear on the surface of the bed.

Consequences: If the part is printed in the area that is cracking, the part will crack too.

Corrective Action: Decrease the Print Heater PID Set Point in 2 °C increments until the crack disappears.

If cracking occurs during the Warm-up stage, you may have ramped up the temperature too quickly. Do not ramp to the final set point until real time calibration starts, (6mm into the warm-up stage).

CRYSTALS AND CONDENSATION

Description: During a print, a thin layer of needle-like crystals and/or a film of condensation forms on cool surfaces in the print chamber. The N flow across the IR Sensor and the laser window will keep the IR sensor and laser window clean, although the user should inspect them before every build.

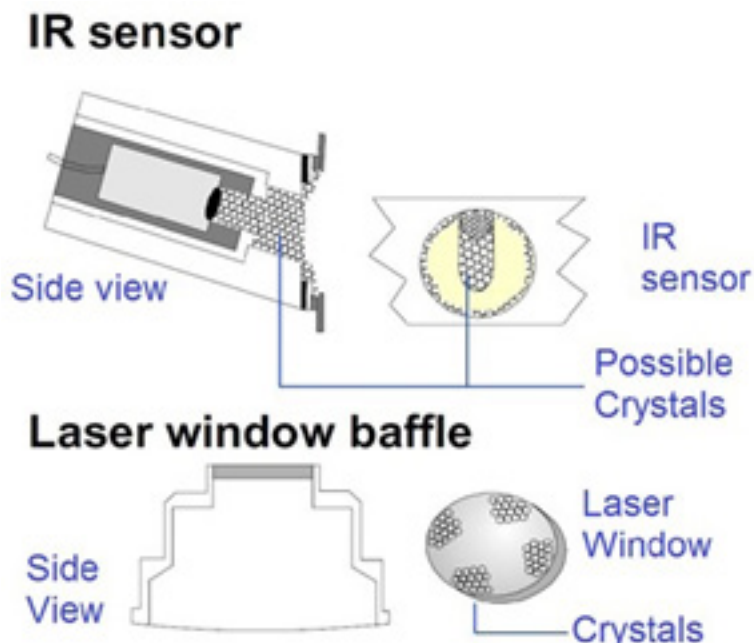



NOTE: A slight amount of condensation will probably form on the laser window every print. If the condensation is extremely heavy across the entire window, call 3D Systems Customer Service; this may indicate a problem with the SLS system.

CURLING, DURING PRINT

Description: Edges or corners of the print rise above the print bed surface.

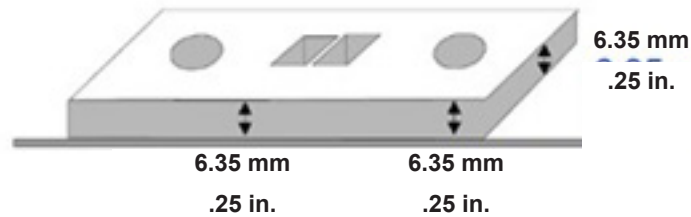

Curling and Z-Inaccuracy

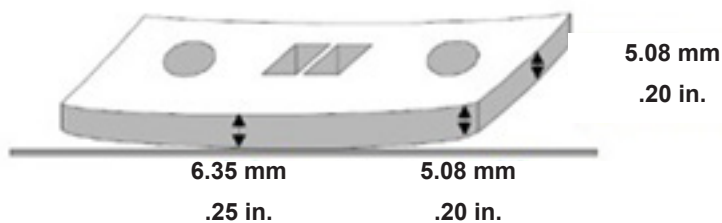

Theory of Cause: During the print, temperature differences in different regions of the print cause uneven shrinkage, which, in turn, causes curling. This usually occurs when the print temperature dips too low after the material is added. Curl during printing can also occur if the print bed temperature is too low.

Visual Signs: The edges of the print rise above the print bed surface after a layer is scanned. Curling usually occurs immediately after a layer of material is added, but a delay sometimes occurs between the addition of the material layer and the observation of curling.

Consequences: Parts (especially those with large surface cross-sections) are not flat. If severe, the print may shift in the print bed when the roller passes it.

Corrective Action: Appropriate corrective actions depend on whether the curling is severe or minor. For minor curling, changes during the print may help.

Once moderate to severe curling has occurred, the part will continue to appear curled even after adjustments have been made.

Increasing the laser power significantly will help a part to stop curling, but this will also cause growth on the part.

If severe curling occurs, you may want to terminate the print and begin a new one. Consider the following changes to prevent the problem in future prints:

- Make sure the system has gone through a full Warm-up stage.
- Check the Feed Hopper Set Point and the Print Heater Set Point.
- Excess feed material may contribute to curling during printing, as some of the feed material may not be hot enough, especially with short layer times.
- Make sure Print Cylinder Heater Enable is set to 1, and Print Cylinder Heater Set Point is set correctly.



NOTE: Adjust parameters carefully to avoid introducing problems caused by too much heat. If you raise the temperatures too much and too quickly, you can cause material caking.

CURLING, POST-PRINT

Description: The final part is not flat, showing curling similar to that experienced with injection-molded parts.

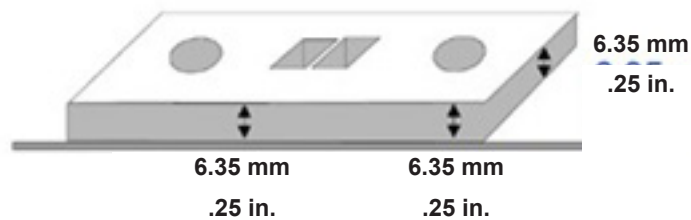

Curling and Associated Z-Shrinkage

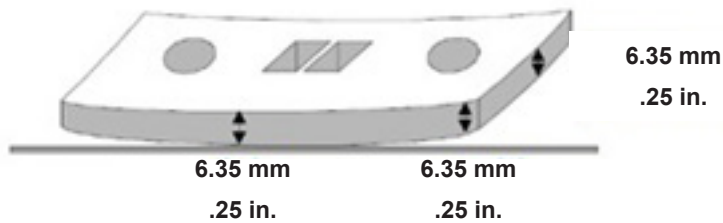

Theory of Cause: When the part is buried during the Print stage, excessive cooling rates and thermal gradients produce unbalanced stresses in it. Excessive cooling rates usually occur on parts printed first in a print job (the parts at the lowest Z levels). You may also have removed the print from the print chamber prematurely.

Visual Signs: The final part is not flat. You cannot observe this until the part is broken out.

Consequences: Curled parts (especially those with large surface cross-sections) are not flat, but the Z dimensions are correct.

Corrective Actions: You can attempt to repair curled parts, and you can change your prints to prevent future runs from curling.

Repairing Curled Parts: Curling can sometimes be reduced or removed from parts by:

1. Clamp the part to a flat plate.
2. Place the part in an oven for one hour at 80° C.
3. Remove the part from the oven and allow to cool for 2 to 4 hours, or overnight, before removing clamps.

Preventing Curl in Prints

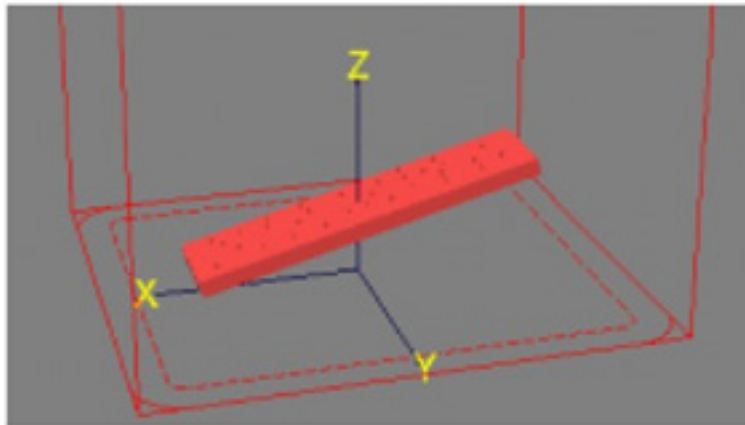

You may want to take one or more of the following actions to prevent parts from curling:

- Your first recourse should be to use the Superheat technique. Refer to the section titled “Superheat”. If this does not fix the problem, try the following steps.
- Add a Heat Barrier: If you are not already using a heat barrier, add a thin layer of throwaway parts below the parts you wish to print.
- Increase Print Bed Set Point: Increase the Print Bed PID Set Point by 1 or 2° C . Increasing the Print Bed PID Set Point too much might cause a more difficult breakout and reduce the amount of material that can be recycled.
- Change Part Orientation: Rotate the part 15° around the Y-axis; this reduces cooling stresses.
- Print in Layers: Print parts at the third or fourth layer of parts in the print cake. For information on setting up a print in layers, Refer to the section titled “Setting Up a Print”.

- **Allow Time to Cool:** Allow the print cake to cool longer than one hour inside the SLS system, and allow the print cake to cool outside the SLS system completely before removing the parts.

GLAZING, DURING PRINT

Description: Small local regions of material melt on the print bed, causing the bed to glisten. This occurs during the print, and should be distinguished from the glazing point. The melting point of DuraForm ProX GF Plastic occurs at approximately 1-to-2° C above the glazing point.

Theory of Cause: There are several possible reasons for glazing:

- The IR sensor is not calibrated correctly or is not clean.
- Uncorrected short feeding.
- The Part Heater Set Point in the Print Profile is too high.
- The system is trying to reach the temperature set point too quickly.

Visual Signs: All or part of the print bed begins to glaze. In extreme cases, the material melts completely.

Consequences: Glazing can affect the uniformity of a layer of material. Parts can be difficult to remove from the print cake during rough breakout. The cake can also shift in the print bed. In severe cases, the print cake may melt and become a solid block.

Corrective Action: If this condition is uncorrected and glazing becomes severe melting, you may not be able to continue the print. You can try to reduce the print bed temperature until the print bed stops melting. If severe melting occurs, terminate the print and remove the melted powder plug, since it will affect the print set points through the next several inches.

There are several actions you can take to prevent glazing. These include:

- In the Print Parameters Profile, reduce the Part Heater Set Point.
- In the Warm-up stage of the Print Profile, ramping the heater set points.
- Use Offline Calibration to make sure IR sensor is calibrated. Refer to the section titled “Offline IR Calibration”.
- If you have performed all the preceding actions and melting still occurs, you may need to call certified service personnel to calibrate the IR sensor.

Related Problems: Refer to the sections titled “Crystals and Condensation” and “Melting, Print Bed”.

GROWTH

Description: Growth occurs as material sinters on the part, blurring features and altering part dimensions.

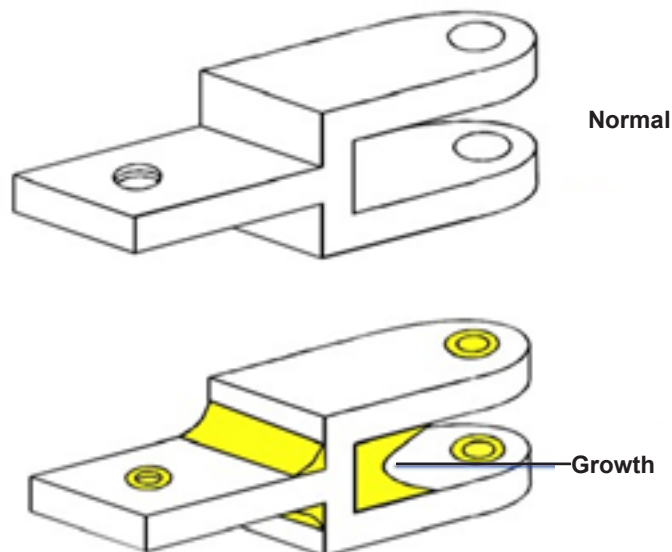

Growth is particularly apparent with small features or small holes. The difference between growth and Bonus Z is that growth may occur on any part edge, while Bonus Z occurs only on downward-facing surfaces.

Theory of Cause: The laser power may be excessive for thick cross-sections, or the print bed temperature may be too high.

Visual Signs: Growth may not be apparent during the print.

Consequences: If the part has detailed features, the features may blur. Parts may be oversized. Parts may be difficult or even impossible to break out.

Corrective Action: Reduce the Part Heater PID Set Point parameter. Reduce the Fill Laser Power parameter.

Related Problems: Refer to the section titled “Wash Out.”

MELTING, PRINT BED

Description: The material in the print bed melts and solidifies.

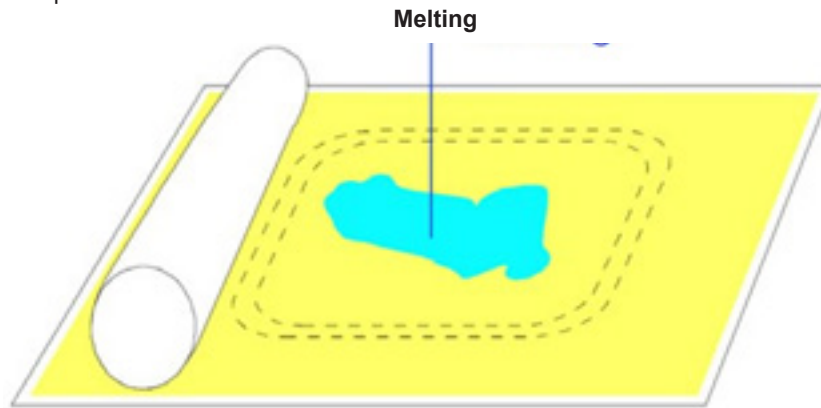

Theory of Cause: Possible causes include:

- IR sensor not calibrated correctly or dirty.
- Part Heater Set Point too high.
- System trying to reach the temperature set point too quickly.

Visual Signs: Melting first occurs in small patches in the hottest areas of the print bed. Observing which areas melt first indicates the hottest spots in your print bed.

Consequences: Melting occurs after glazing. The print bed temperature increases. Melting is a far more serious condition than glazing.

Corrective Action: Terminate the build. There are several actions you can take to prevent melting.

These include:

- In the Print Parameters Profile, reduce the Part Heater Set Point and/or use ramping for the heater set points.
- Make sure IR sensor block temperature is correct and that the core heater is working.
- Perform an Offline IR sensor calibration. Refer to the section titled “Offline IR Calibration.”
- Refer to the section “Cleaning Up the SLS System.”
- If none of the above actions prevents melting, call certified service personnel to calibrate the IR sensor and/or adjust the thermocouples.

Related Problems: Review the sections titled “Cracking of Print Bed,” “Crystals and Condensation, and “Glazing, During Print”.

MISSED SCAN

Description: The laser does not completely scan the fill area in a part.

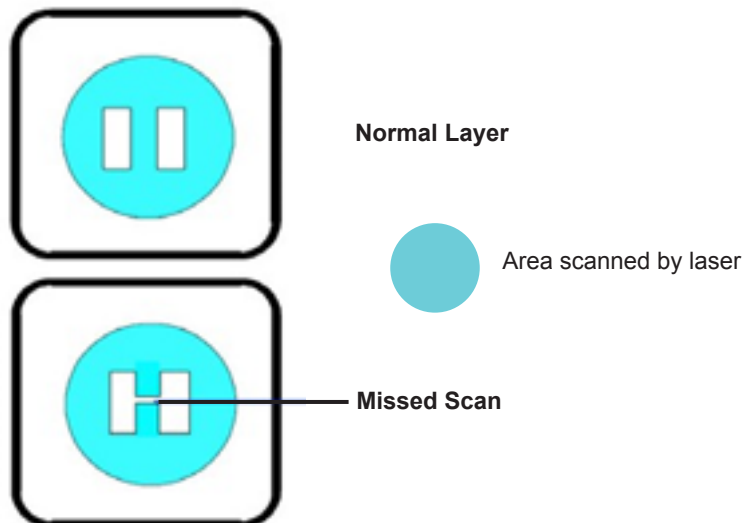

Theory of Cause: The STL file is incorrect. This problem is not material related.

Visual Signs: You can observe that the scanned area is incorrect.

Consequences: The part geometry is incorrect, and the part may have poor properties.

Corrective Action: Depending on the severity of the problem, you may need to terminate the print and start over. If the missed scan occurs only on one layer or slice, you may be able to complete the print.

If you experience missed scans, make it a practice to verify that the STL file is not missing facets and that the normals are correct prior to beginning a print by using the Preview application. If the STL file is incorrect, you next need to verify that the original CAD file is correct.

If the original CAD file is correct, the STL file could be corrupt. Generate a new one and preview the print again. If the problem recurs, contact 3D Systems customer support.

If the original CAD file is incorrect, make the necessary changes to the CAD file and save the file in STL format. Using the new file, set up a build packet and print the part again.

Related Problems: Review the section titled “Stray Vectors.”

ORANGE PEEL

Description: Vertical surfaces on the part have voids or recesses that create a distinctive orange-like texture. This problem usually appears on surfaces printed parallel to the front of the system.

Theory of Cause: Lack of density at the part’s surface, caused by excessive reuse of the material or thermal problems in the print chamber.

Visual Signs: None.

Consequences: Although other part properties remain unchanged, surface finish and appearance are affected.

Corrective Action: Take one of the following actions:

- Verify that you are following correct sifting and recycling procedures and correct any problems. See “Sifting Material” on page 10 and “Recycling Material” on page 10.
- Use a higher ratio of fresh powder to used powder.
- Increase the post- and/or pre-add powder delays.
- In the Part Profile, increase the laser power.
- In the Print Profile, increase Part Heater Set Point.

Related Problems: Review the section titled “Weak Parts/Porosity”.

SHORT FEEDS

Description: The roller does not deliver enough material to cover the previous layer.

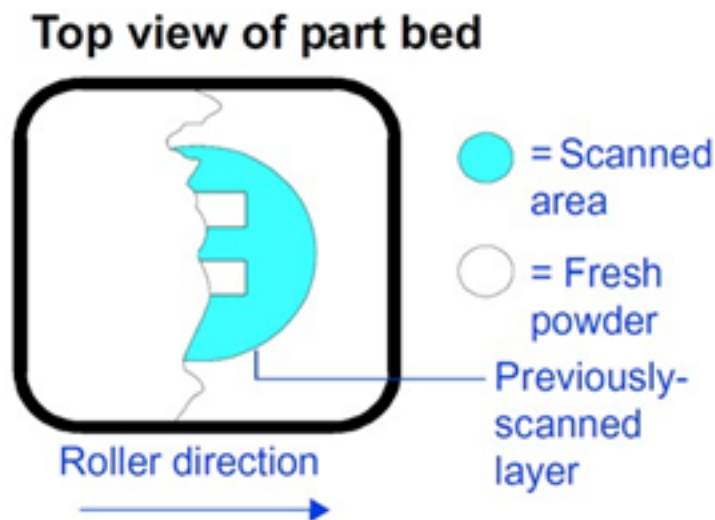

Theory of Cause: Short feeds can occur when the feed amount is too short, the part cross-section changes from small to large.

Visual Signs: See Description.

Consequences: The part will usually be weak, may delaminate at layers where short feeds occurred, and may have surface imperfections.

Corrective Action: Increase the Feed Amount parameters in the Print Parameters Profile or use the Prime Cycle button.



Caution: Exercise care when varying the Feed Amount parameters. The feed material during a print is considerably cooler than the material in the print bed. Using a feed that is too large can cause excessive cooling of the part as the material is delivered, which will lead to curl during printing and prematurely exhaust the material.

You also may want to use the Prime Cycle button to cover the part.

Related Problems: Review the sections titled “Melting, Print Bed” and “Weak Parts/Porosity.”

STRAY VECTORS

Description: A line occurs between two fill areas where it should not be.

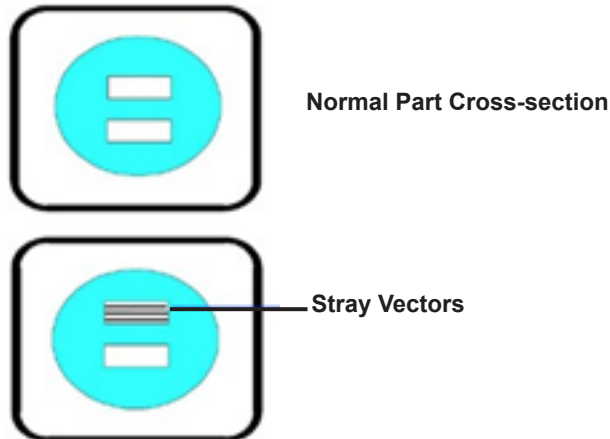

Theory of Cause: The STL file is incorrect. The vertices of the facet do not meet. This is not material-related.

Visual Signs: The laser scans an area in the cross-section that it should not scan. This usually results in one or more lines connecting the fill areas.

Consequences: Stray vectors make it more difficult to clean and break out parts.

Corrective Action: Prior to beginning the print, check the STL file for stray vectors using the Preview tab in Build Setup. Rotate the orientation of the part slightly. Preview the part again. Verify the original CAD file.

If the original CAD file is correct, the STL file has probably been corrupted and you must make a new one. Repeat the process to save the file into the STL format, copy the new file to the SLS system computer, and, using the new file, set up a build packet and preview it again. If the problem recurs, contact 3D Systems customer support.

If the original CAD file is incorrect, make the necessary changes to the CAD file, save the file into the STL file format, and copy the new file onto the SLS system computer. Using the new file, set up a build packet and print the part again.

If the stray vectors are not too severe, file or cut them off. If the problem is too severe, you may need to terminate the print; trying to remove severe stray vectors from the part during breakout may cause the part to break.

Related Problems: Review the section titled “Missed Scan”.

WASH OUT

Description: Downward facing corners lose definition and become rounded.

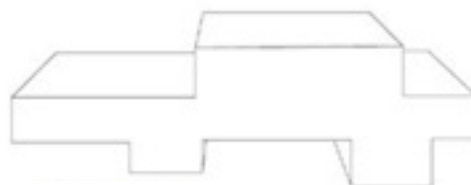

Normal Part



Washed-out Part

Theory of Cause: As a melted part cools, heat is transferred to the surrounding material, causing the material to bond to the part surfaces (growth). Part corner regions cool faster than flat regions, so corners exhibit less growth than surfaces, which causes the appearance of rounded corners.

Visual Signs: You can observe wash out when small slots fill in with melted material. Otherwise, wash out is observed on parts after breakout.

Consequences: The part features become rounded, mostly on the downward-facing surfaces. Wash out may be followed by growth. If you correct part wash out early enough, you can continue the print with little observable growth; however, you can still observe wash out in the finished part.

Corrective Action: Reduce the Fill Laser Power parameter. Periodically, you may want to run a set of parts with fine features at different laser powers to optimize the Fill Laser Power parameter.

Related Problems: Review the section titled “Bonus Z,” “Growth” and “Melting, Print Bed.”

WEAK PARTS/POROSITY

Description: Parts are brittle and appear porous and opaque rather than translucent.

Theory of Cause: The laser window has been covered with heavy condensation, or the laser power is not high enough. When DuraForm ProX GF Plastic is recycled, more laser power can be required to achieve full density.

Visual Signs: There is little observable contrast between melted and non-melted areas in the print bed.

Consequences: The part will have low strength and density. Curl during printing may occur. Parts printed with DuraForm ProX GF Plastic material can tolerate some porosity if you want extremely crisp, sharp details and edges. Porous parts’ mechanical properties (such as failure strain and tensile strength) are approximately one-third to one-half the corresponding qualities of fully dense parts.

Corrective Action: To minimize the problem, you can:

- Clean the laser window (see “Cleaning the Laser Window,” 10).
- Increase the Fill Laser Power parameter during the build.
- Increase the Print Bed Temperature PID Set Point parameter.
- Discard the old material and replace it with unused material.

If these actions do not improve part density, call service personnel to check the laser and laser focus.

Related Problems: Review the section titled “Crystals and Condensation.”



3D Systems, Inc.

333 Three D Systems Circle | Rock Hill, SC 29730 | **USA**

www.3dsystems.com

©2016 3D Systems, Inc. All rights reserved.

PN: 134015-00 Rev. B