

Keys to Successful RealWax™ Casting

Stacie Hoche

Revision C, June 2011

Recommendations for Foundries

- Information about wax patterns to communicate with the foundry
 - Wax part temperatures
 - The CP and CPX patterns become brittle if cold.
 - Keep parts at room temperature around 72⁰F 22⁰C .
 - Storing parts
 - Wax parts sag over time if not supported when stored.
 - Its recommended that you invest the patterns as fast as schedule allows
 - Casting de-bubbler solution
 - Most bubble prevention solutions contain alcohol which can pit the part surfaces.
 - Test your specific de-bubbler to verify it does not cause surface defects
 - When using de-bubbler process tree assemblies immediately versus spraying and waiting until morning to process.

Recommendations for Foundries

- Information about wax patterns to communicate with the foundry
 - RealWax processes just like standard investment casting wax.
 - RealWax is more brittle than standard investment casting wax.
 - RealWax has a lower melting temperature than most investment casting waxes.
 - RealWax melts at 80°C 176 °F

Wax Quantities

- Foundries have a standard wax/casting yield
 - On average this is 95%
 - Its recommended that you supply 105%+ wax patterns to address this yield
- Examples
 - 1 casting required/2 wax parts delivered
 - 5 casting required/6 wax parts delivered
 - 20 casting required/21 wax parts delivered
 - 40 casting required/42 wax parts delivered

Part Design Guidelines – Casting Scale

- Metal shrinks as it cools
 - To produce accurate metal cast part, the master is larger or scaled up, so the cast part which shrinks turns out the correct size
- Part Shrink value
 - Work with your foundry to determine what shrink values to apply to your RealWax part
 - The X, Y and Z directions all may have different Shrink values
- Assigning Shrink Values
 - Load the part into the ProJet Client software and scale the part in the PrintPreview window

Part Design Guidelines – Casting Scale

Part Design Guidelines - Support

- As with conventional wax patterns, fragile geometry can distort. With digital RealWax patterns you can:
 - CAD Design in complex stabilizing mounts to the parts to prevent sag or break.
 - The mounts can be removed during the wax up
 - Or they can be used as gates and sprue

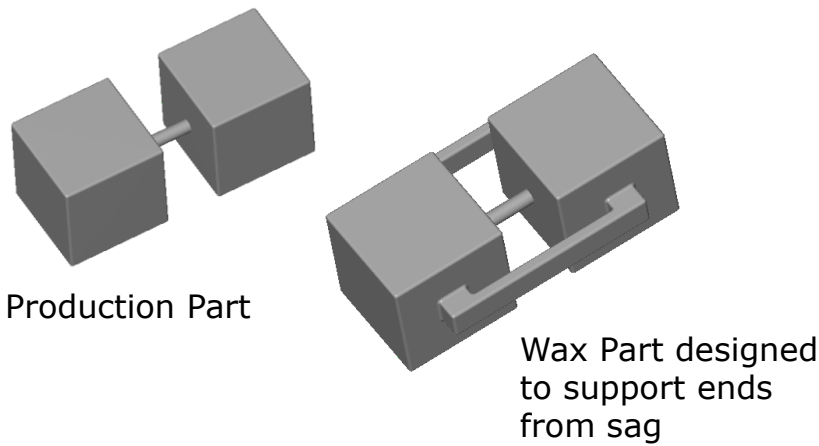

Production Part

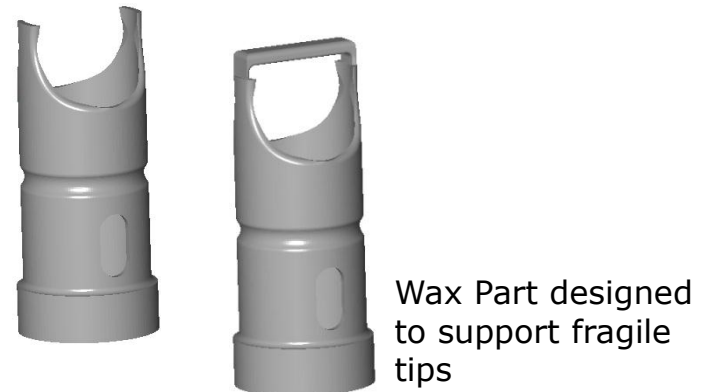

Part Design Guidelines - Gating

- Add gate contacts to the part
 - Determine where the part is going to be gated and add the contact points to the part
 - CAD Design the contact points on the part make for easier and cleaner removal when the part is in the metal state.

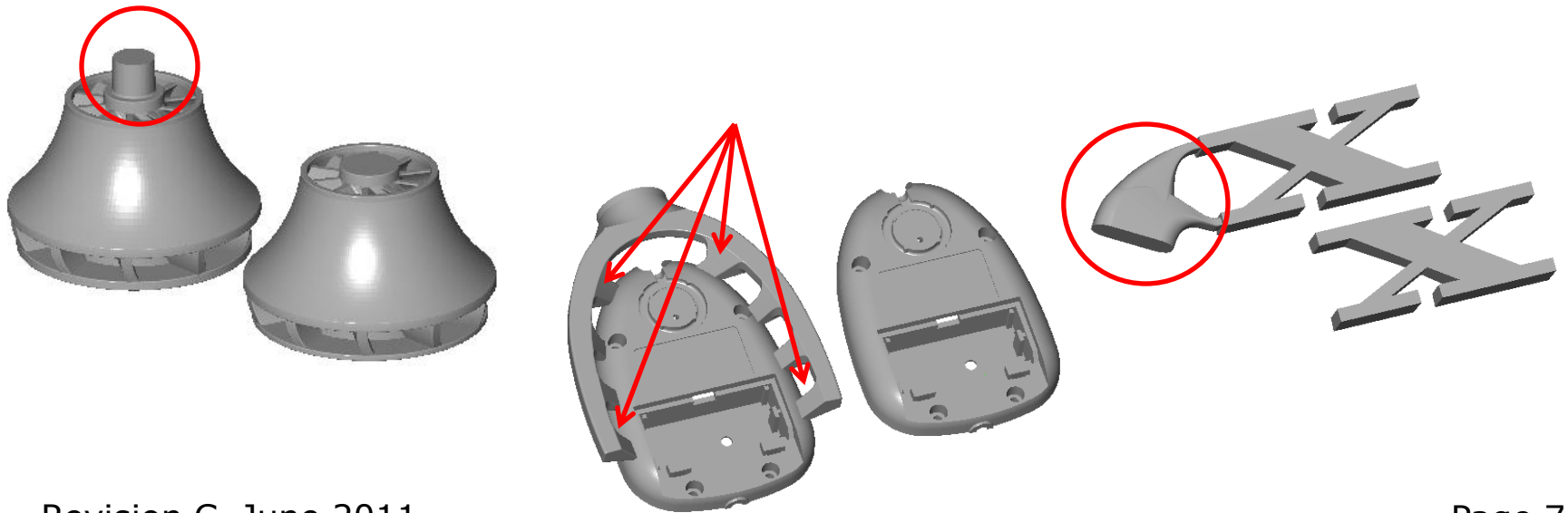



Part Design Guidelines - Fillets

- Filet all sharp edges
 - Sharp edges are weak areas
 - Metal does not flow well with sharp edges

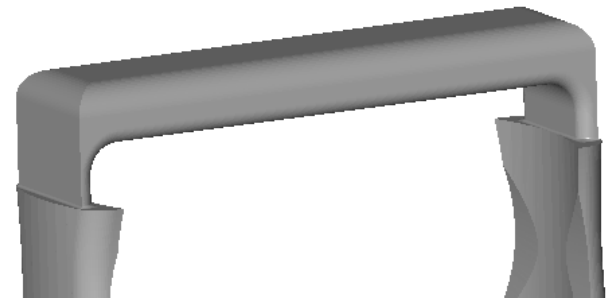

 Supports added with no fillets



 Supports added with fillets

Part Shipping Guidelines

- As with conventional wax patterns, isolate Fragile Real Wax patterns from stress and shocks during shipping
- Suggested Shipping method for larger Parts:
 - Use Buffalo Snow for wrapping the part
 - Use a super seal shrink wrap machine to bag the parts.(not too tight this will load the pattern)
 - Float the parts in a box with peanuts



Part Shipping Guidelines

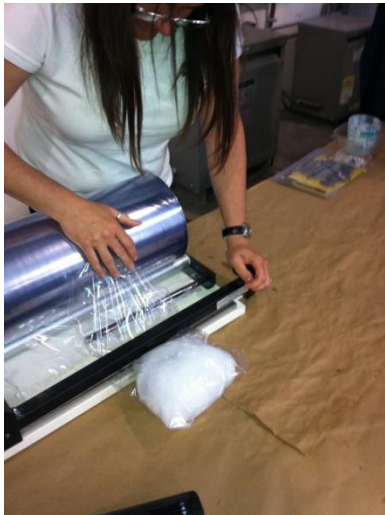

Part Shipping Guidelines

- Suggested Shipping method for small parts:
 - Place parts in a small box
 - Place a paper towel on top of the part
 - Close the lid



Part Cleaning Guidelines

